

The HT10534 was designed specifically with the objective of securing plastic containers, pallets and other metallic RTIs. It features a very thin form factor so that the tag does not protrude much from the surface. Optimized to perform on all surfaces and ensures excellent read range of up to 8 meters.

TYPICAL APPLICATIONS

- Waste Management Bins
- Plastic and Metallic RTI's

PHYSICAL SPECIFICATION

Tag Material	ABS
Tag Dimensions	105 x 34 x 3.5 mm 4.13 x 1.33 x 0.13 inch
Adhesive(Optional)	High performance permanent adhesive with excellent bonding to a variety of substrates
Weight	11.40 g
Delivery Format	Single Pieces

RF SPECIFICATION

Mode of Operation	Passive
Device Type	Plastic Hard Tag
Air Interface Protocol	EPC Gen2/ISO/IEC 18000 6C
Operational Frequency	ETSI: 865 - 869 MHz FCC: 902 - 928 MHz
IC Type*	Alien Higgs3
Memory Configuration	EPC Size 96 Bits, User Memory 512 Bits, 96 bits TID with 64 bits Unique serial number
Write Cycle Endurance	100,000
Data Retention	Upto 50 years
Applicable Surface Materials	All surfaces
Read Range (In Meters)	ETSI : Free Air upto 10 m FCC : Free Air Upto 10 m

ENVIRONMENTAL RESISTANCE

Operating Temperature	-50°C to +85°C / -58°F to +185°F
Withstands Exposure To	-50°C to +85°C / -58°F to +185°F
Peak Temperature	+85°C / +185°F
Adhesive Service Temperature	-40°C to +148°C / -40°F to +298.4°F
Recommended Application Temperature	+10°C to 38°C / +50°F to +100.4°F
Water Resistance (IP Rating)	IP68
Chemical Resistance	No physical or performance changes in: - 168 h Salt water (salinity 10%) exposure - 168 h Motor oil exposure - 12 h NaOH (10%) exposure - 30 min Acetone exposure
Ideal Storage Condition	+23°C / +73.4°F , 50% RH
Expected Lifetime	Years in normal operating conditions

PRODUCT INSTALLATION



The tag can be attached to the surface using the following fixing methods

- **Adhesive:**
The tag is delivered with an optional adhesive attached. While mounting the tag ensure clean and dry surface to achieve maximum bond strength. Ideal application temperature is from +10°C to 38°C / +50°F to +100.4°F and installation beyond this temperature range is not recommended. Bond strength can be improved by applying pressure firmly while mounting the tag.
- **Mechanical Fixing:**
Achieved by using a screw or a pop rivet and is a recommended for environments that involve high mechanical stress. During fixing make sure there is no air gap left in between the metal surface and tag.
- **Cable Tie:**
Metallic or plastic cable ties can also be used to mount the tag onto the surface.

PERSONALIZATION OPTIONS

Pre-encoding

- Customer specific encoding of EPC

Customized Laser Engraving

- Customer specific layout including logo, text, and numbers.

ORDER INFORMATION

Part Number

- RF.HT.10534.H3

No. of Pieces

- 250 per box.

RADIATION PATTERN & READ RANGE GRAPH (ETSI)

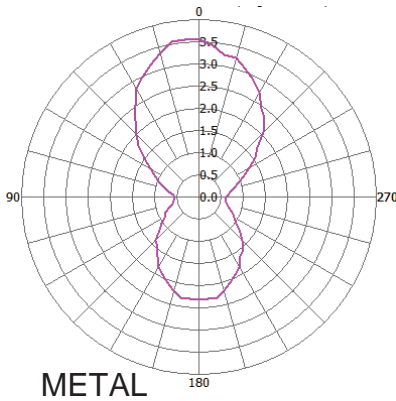

METAL

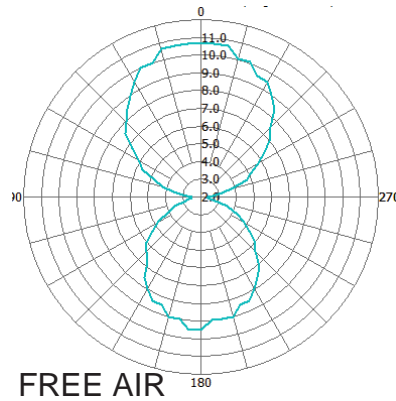

FREE AIR

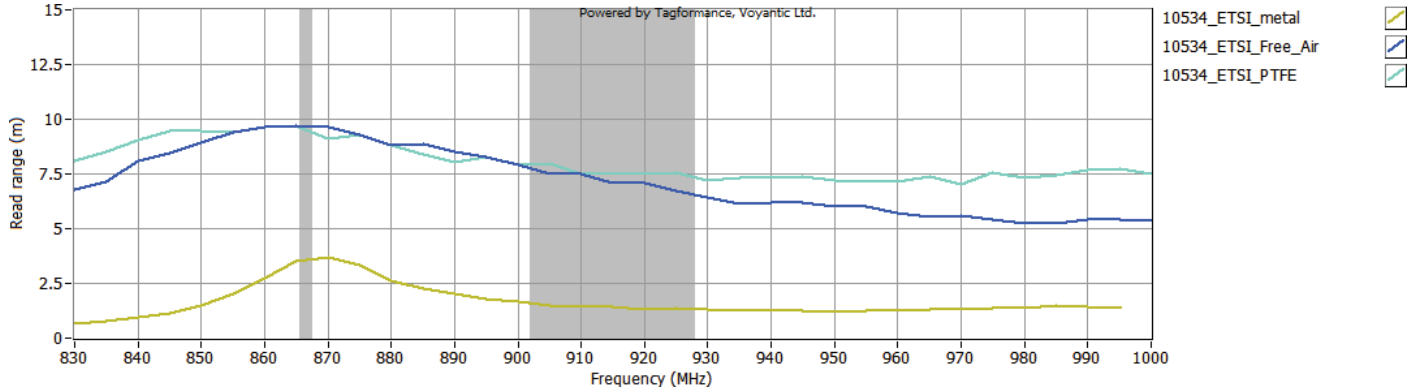

RADIATION PATTERN & READ RANGE GRAPH (FCC)

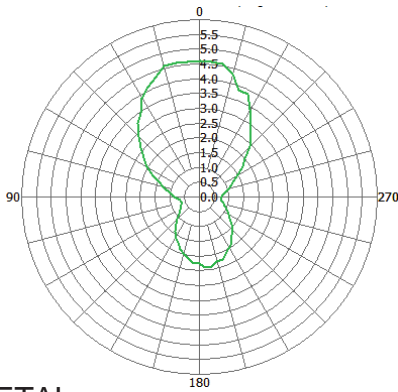

METAL

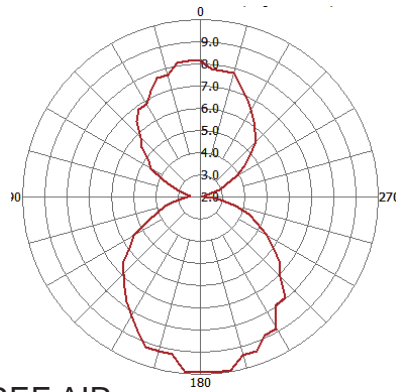

FREE AIR

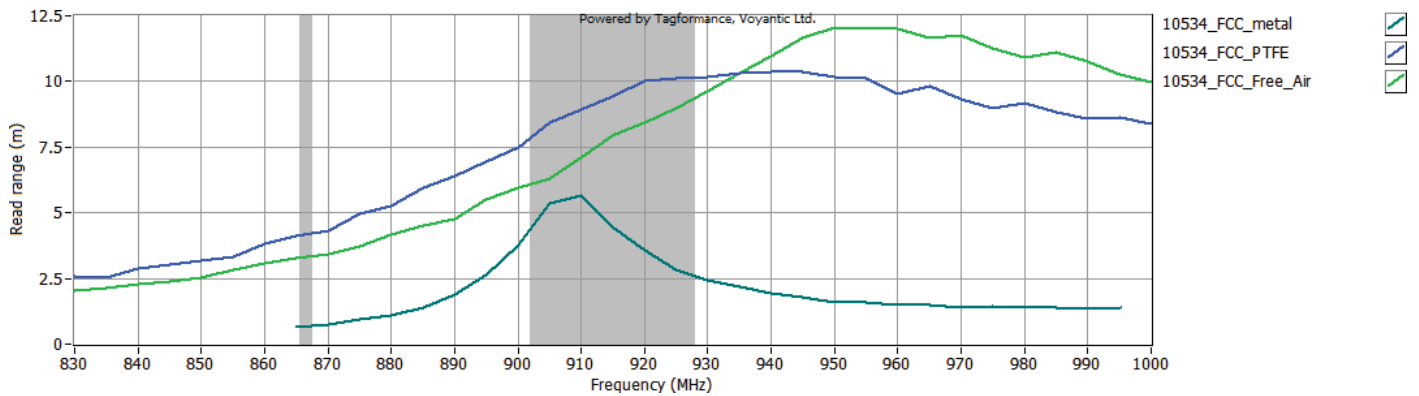

* Other IC's available on request

** The indicated read range values are measured in our laboratory testing environment, where antennas with optimum directivity are used with maximum allowed operating power. Different surface materials and environments may exhibit different results.



Version : 131219.01