

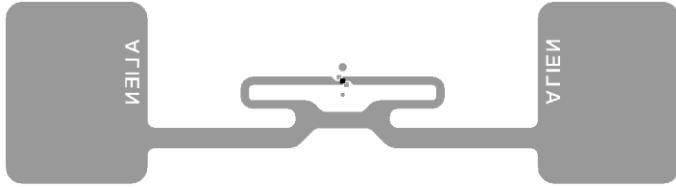

ALN-9768 Wonder Dog™ Inlay

The Alien Technology® ALN-9768 “Wonder Dog” is a multi-faceted UHF RFID inlay suitable for many uses. While useful in many general purpose applications, it is particularly effective when used close to metals, liquids and glass. It also performs well with low power readers such as handheld UHF readers.



Applications

- Automotive, windshields & head lamps
- Consumer electronic appliances
- Set TopBoxes
- Bottled liquids
- General Purpose Applications

FEATURE	DESCRIPTION	BENEFIT
Tuned for use close to RF reflective or absorbing materials	Tag designed to power up (high sensitivity) when mounted close to metal. Also sensitive enough for use on fluid filled bottles.	Can be used on windshields containing metalized reflective sun protection, consumer electronic appliances, liquid filled bottles or general purpose applications.
High backscatter	Tag is highly efficient at reflecting power back to the reader antenna.	Tag work well with low power readers such as handheld units that provide little transmit power
Next generation Higgs™ 4 features and performance	A mass-market optimized tag with class leading read and write performance. Supports Aliens <i>QuickWrite™</i> and <i>BlastWrite™</i>	Rapid programming of serialized tags and excellent read/write performance

Features:

- › Designed to meet EPCglobal Gen2 (V1.2.0) and ISO/IEC 18000-6C
- › Worldwide operation in the RFID UHF bands (840-960 MHz)
- › 448-Bits of NVRAM Memory
 - 128-EPC Bits
 - 128 User Bits
 - 64 Bit Unique TID
 - 32 Bit Access and 32 bit Kill Passwords
- › Pre-Programmed with a unique, unalterable 64-bit serial number
- › User Memory can be Block Perma-Locked as well as read password protected in 32 Bit Blocks
- › Class leading read and write performance
- › *BlastWrite™* and *QuickWrite™* mass-encoding
- › Dynamic Authentication™ - anti-cloning/anti-counterfeit technology
- › Exceptional operating range, up to 11m with appropriate antenna.
- › Available in high-yield, high capacity dry/wet inlay rolls

Product Overview:

Powered by Alien®’s break-through **Higgs™4 UHF RFID IC** and innovative “**Wonder Dog™**” antenna design, the ALN-9768 delivers industry leading EPC Gen 2 performance and reliability for general purpose, automotive and consumer electronics tagging applications.

With its Higgs-4 core, the “WD” delivers next generation read and write performance, yet is completely **optimized for the highest volume enterprise, retail, and automotive applications.**

An optimized memory footprint includes a 32-bit TID, a **64-bit Unique TID for authentication** and **next generation serialization** applications, a 128-bit EPC memory bank, 128-bits of user memory for distributed data applications, and **password protected read and write** support capabilities to prevent unauthorized viewing and modification of the tag’s data.

ALN-9768 inlays are World Tag compliant, enabling consistent operation across the diverse frequencies of the Americas, Europe, Middle East, Asia, and Africa.





ALN-9768 Wonder Dog™ Inlay

All dimensions in millimeters unless specified otherwise

ALN-9768 Basic Dimensions

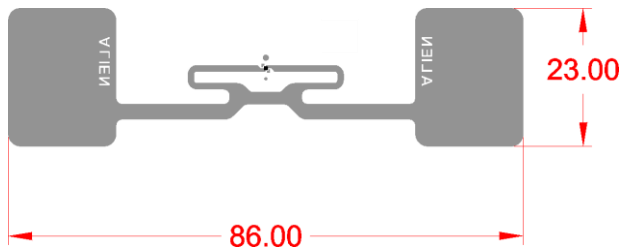

ALN-9768 Dry

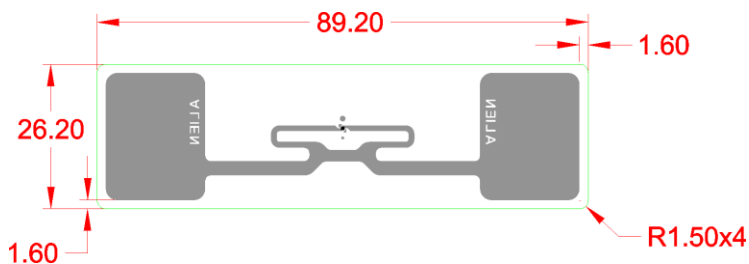

ALN-9768 Wet

ALN-9768 Inlay Orientation

Standard Alien Inlay rolls unwind with metal antenna side facing outward, with respect to the core.

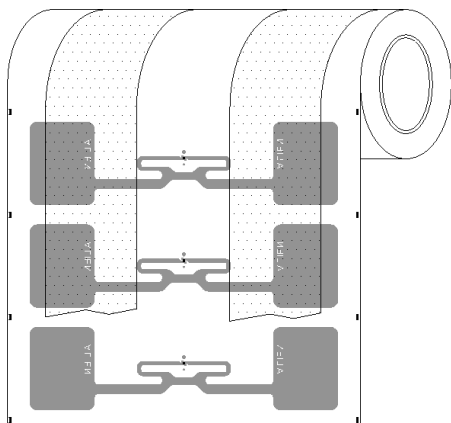

ALN-9768-R
(Dry Unslit Roll)

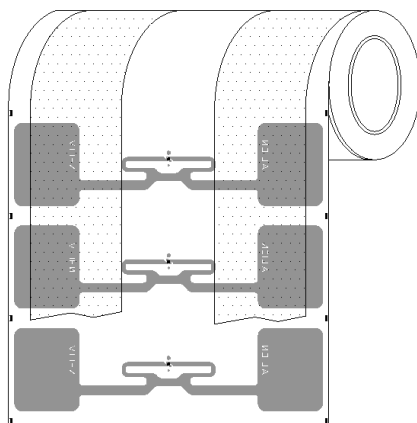

ALN-9768-SR
(Narrow Dry Unslit Roll)

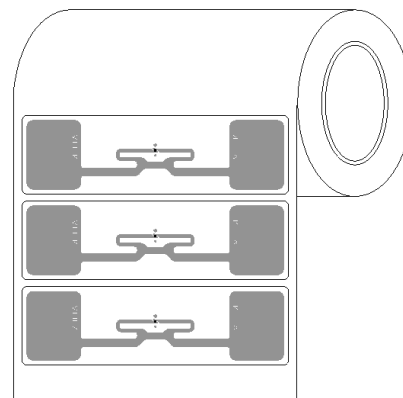

ALN-9768-WRW
(White Wet Roll Inlay)

ALN-9768 Inlay Specification

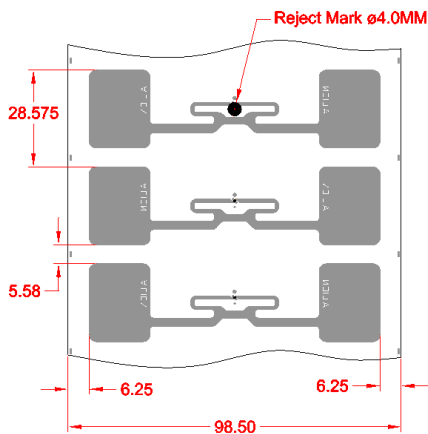

ALN-9768-R
(Dry Unslit Roll)

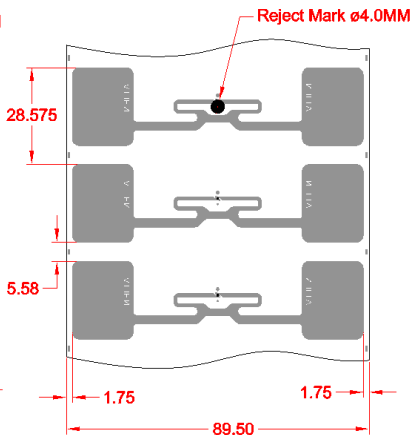

ALN-9768-SR
(Narrow Dry Unslit Roll)

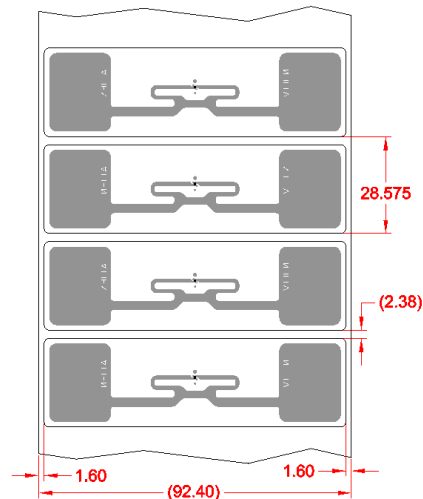

ALN-9768-WRW
(White Wet Roll Inlay)



ALN-9768 Inlay Stackup

DRY INLAY THICKNESS, ±10%	
OVER ANTENNA	0.05 mm
OVER CHIP	0.25 mm

WHITE WET INLAY THICKNESS, ±10%	
OVER ANTENNA	0.16 mm
OVER CHIP	0.36 mm



ALN-9768-R/SR
(Dry Unslit/Slit Roll)

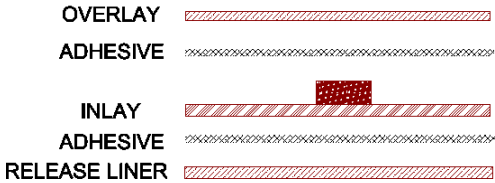

ALN-9768-WRW
(White Wet Roll Inlay)

ALN-9768 Inlay Angular Sensitivity

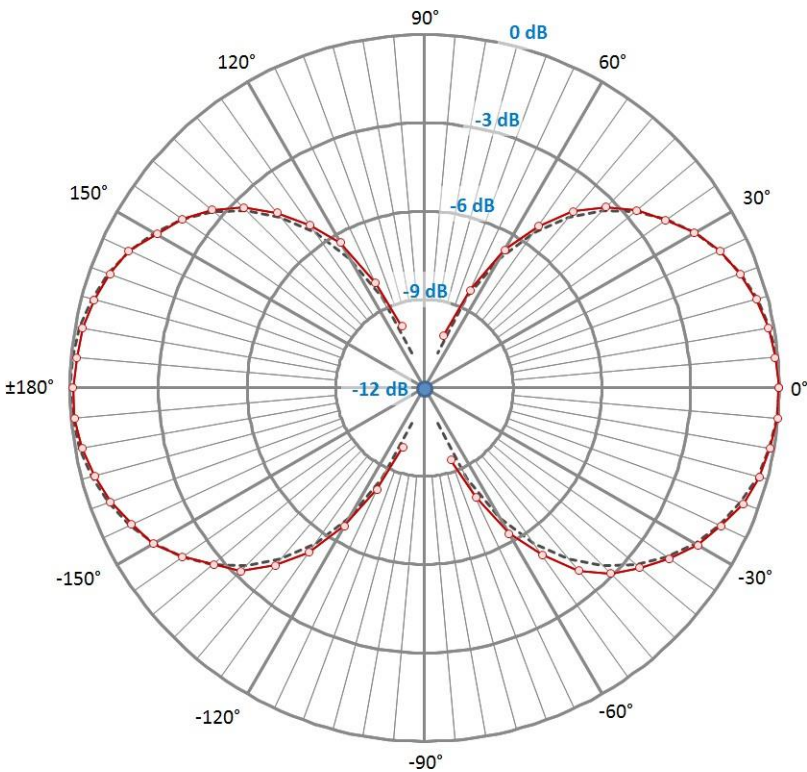

Angular Sensitivity
(Relative Read Range vs. Orientation)

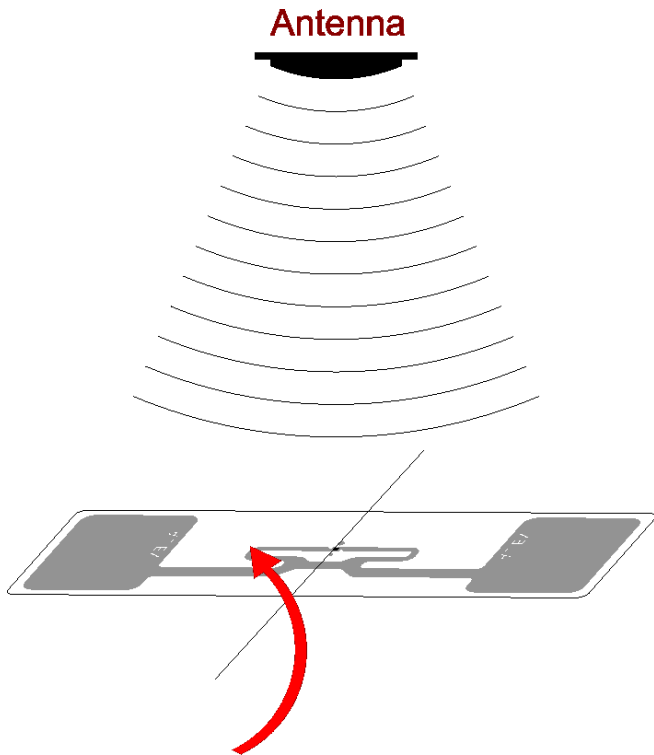

Angular Sensitivity
Inlay is rotated in the x, y, plane about the z axis

ALN-9768 Specifications

Dry Inlay	Unslit ALN-9768-R	Narrow Slit ALN-9768-SR
Antenna Width	3.39" [86mm]	
Antenna Length	0.91" [23mm]	
Web Width	3.88" [98.5mm]	3.52" [89.5mm]
Web Pitch	1.125" [28.575mm]	
Core Width	3.88" [98.5mm]	3.52" [89.5mm]
Core ID	6" [152.4mm]*	
Core Material	Fiberboard	
Inlays per Roll	12,500 Nominal	12,500 Nominal
Maximum Roll OD	< 12" [304.8mm]	
Roll Labeling Data	Roll #, Quantity	

Wet Inlay	ALN-9768-WRW
Inlay Width	3.51" [89.2mm]
Inlay Length	1.03" [26.2mm]
Web Width	3.64" [92.4mm]
Web Pitch	1.125" [28.575mm]
Core Width	3.64" [92.4mm]
Core ID	6" [152.4mm]*
Core Material	Fiberboard
Inlays per Roll	12,500 Nominal
Maximum Roll OD	< 16" [406.4mm]
Roll Labeling Data	Roll #, Quantity
White	TT Printable White Film Only
Overlay Adhesive	General Purpose Permanent
Inlay Adhesive	General Purpose Permanent
Adhesive Application Temperature	> +25°F [-4°C]
Adhesive Service Temperature	-40°F to +200°F [-40°C to +93.3°C]
Release Liner	40# SCK

* Shipped with 6" to 3" plastic core adapter

July 5, 2016

Copyright © 2016 Alien Technology LLC. All rights reserved.

Alien, Alien Technology, the Alien Technology logo, Spider, Higgs, Dynamic Authentication, QuickWrite, BlockWrite, Squiggle, and the Squiggle logo are trademarks or registered trademarks of Alien Technology Corporation in the U.S. and other countries.

HANDLING PRECAUTIONS Observe standard handling practices to minimize ESD.

DISCLAIMER Application recommendations are guidelines only - actual results may vary and should be confirmed. This is a general purpose product not designed or intended for any specific application.

This product is covered by one or more of the following U.S. patents: 7967204, 7931063, 7868766, 7737825, 7716208, 7716160, 7688206, 7659822, 7619531, 7615479, 7598867, 7580378, 7576656, 7562083, 7561221, 7559486, 7559131, 7554451, 7551141, 7542301, 7542008, 7531218, 7522055, 7510610, 7489230, 7453705, 7425467, 7417306, 7411503, 7385284, 7377445, 7364084, 7353598, 7342490, 7324061, 7321159, 7301458, 7295114, 7288432, 7265675, 7262686, 7260882, 7253735, 7244326, 7218527, 7214569, 7199527, 7193504, 7173528, 7172910, 7172809, 7141178, 7131320, 7101502, 7080444, 7070851, 7068224, 7046328, 6998644, 6988667, 6985361, 6980184, 6970219, 6952157, 6942155, 6933848, 6927085, 6816380, 6780696, 6731353, 6693384, 6683663, 6665044, 6657289, 6623549, 6606247, 6606079, 6590530, 6586338, 6582744, 6555408, 6527964, 6479395, 6468638, 6420266, 6316278, 6291896, 6281038. Other patents pending.

This product is licensed under patents of Round Rock Research, LLC, for use solely with UHF RFID Readers (such as Alien reader products) that are licensed under an agreement with Round Rock Research, LLC.

Environmental	
Shelf Life	Dry Inlays: 5 years at +77°F [+25°C] @ 40% RH
	Wet Inlays: 2 years at +77°F [+25°C] @ 40% RH
Recommended Storage	+77°F [+25°C] @ 40% RH
Storage Limits	-13°F to 122°F [-25°C to +50°C] 20% to 90% RH Non-condensing
Operating Limits	-40°F to +158°F [-40°C to +70°C] 20% to 90% RH Non-condensing
Bend Diameter	> 1.97" [50mm]
Pressure	< 5N/mm ²
Drop Resistance	Per ASTM D5276
Write Cycles	100,000 @ 25°C
RoHs	2002/95/EC, 2005/618/EC, 2011/65/ EU Compliant
REACH	1907/2006/EC Compliant (SVHC and ECHA)
ESD Limit- HBM / CDM	5.0kV / 1.5kV

RFID	
Protocols Supported	ISO/IEC 18000-6C EPCglobal Class 1 Gen 2
Integrated Circuit	Alien Higgs-4
Operating Frequency	840-960 MHz
EPC Size	128 Bits
User Memory	128 Bits
TID	32 Bits
Unique TID	64 Bits
Access Password	32 Bits
Kill Password	32 Bits