

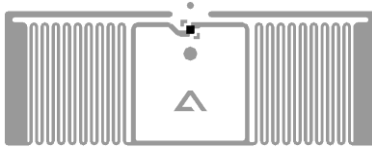

“Glint” Jewelry/Cosmetics Inlay

The Alien Technology® ALN-9715 “Glint” RFID inlay is designed for use in jewelry and cosmetic applications where the tag may be in close proximity to small metal or metallic coated objects



Applications

- Jewelry tagging
- Use with small metallic objects
- Cosmetics

FEATURE	DESCRIPTION	BENEFIT
Small form factor, non-near field read tag	Despite its diminutive size (27 x 9.7mm), this tag uses conventional long range UHF antenna unlike many other competitive tag solutions.	Offers read/write distances in the order of feet/meters unlike other competitive tags that are near-field and only read an inch or two.
Tuned for metal and cosmetics	Designed to be in close proximity to metal or metallic surfaces.	Uses the metal surfaces to “amplify” the read/write distance of the tag.
Next generation Higgs™ 4 features and performance	A mass-market optimized tag with class leading read and write performance. Supports Aliens <i>BlastWrite™</i> and <i>QuickWrite™</i> mass-encoding	Rapid programming of serialized tags and excellent read/write performance

Features:

- › Designed to meet EPCglobal Gen2 (V1.2.0) and ISO/IEC 18000-6C
- › Worldwide operation in the RFID UHF bands (840-960 MHz)
- › 448-Bits of NVRAM Memory
 - 128-EPC Bits
 - 128 User Bits
 - 64 Bit Unique TID
 - 32 Bit Access and 32 bit Kill Passwords
- › Pre-Programmed with a unique, unalterable 64-bit serial number
- › User Memory can be Block Perma-Locked as well as read password protected in 32 Bit Blocks
- › Class leading read and write performance
- › *BlastWrite™* and *QuickWrite™* mass-encoding
- › Dynamic Authentication™ - anti-cloning/anti-counterfeit technology
- › Available in high-yield, high capacity dry/wet inlay rolls

Product Overview:

Powered by Alien®’s break-through **Higgs™ 4 UHF RFID IC** and **innovative “Glint” antenna design**, the ALN-9715 delivers industry leading EPC Gen 2 performance and reliability for retail jewelry and cosmetics especially when tagging in compact and highly dense areas.

With its Higgs-4 core, the Glint delivers next generation read and write performance, yet is completely **optimized for the highest volume enterprise and retail applications.**

An optimized memory footprint includes a 32-bit TID, a **64-bit Unique TID for authentication** and **next generation serialization** applications, a 128-bit EPC memory bank, 128-bits of user memory for distributed data applications, and **password protected read and write** support capabilities to prevent unauthorized viewing and modification of the tag’s data.

ALN-9715 inlays are World Tag compliant, enabling consistent operation across the diverse frequencies of the Americas. Europe. Middle East. Asia. and Africa.

For more information, visit: www.rfidcanada.com Email:

info@rfidcanada.com

+1 905-513-8919



All dimensions in millimeters unless specified otherwise

ALN-9715 Antenna Size

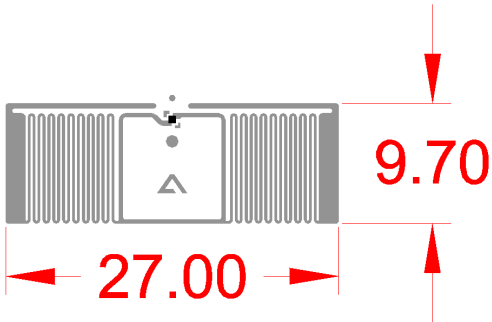

ALN-9715 Inlay Orientation

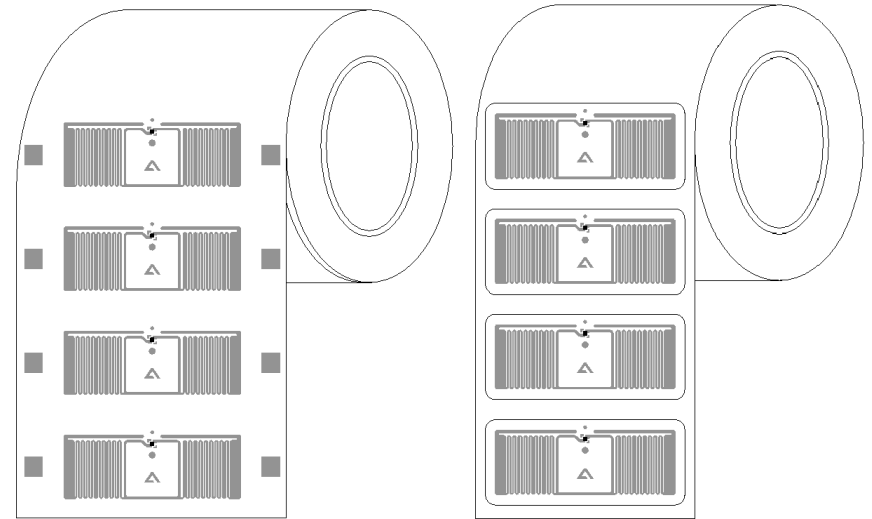

ALN-9715-R
(Dry Unslit Roll)

ALN-9715-WRW
(White Wet Inlay)

Standard Alien Inlay rolls unwind with metal antenna side facing outward, with respect to the core.

ALN-9715 Inlay Specification

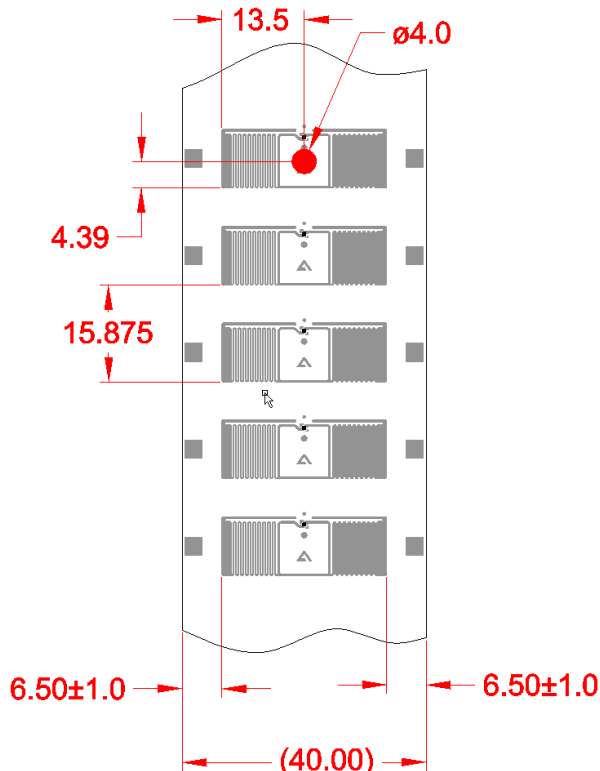

ALN-9715-R
(Dry Unslit Roll)

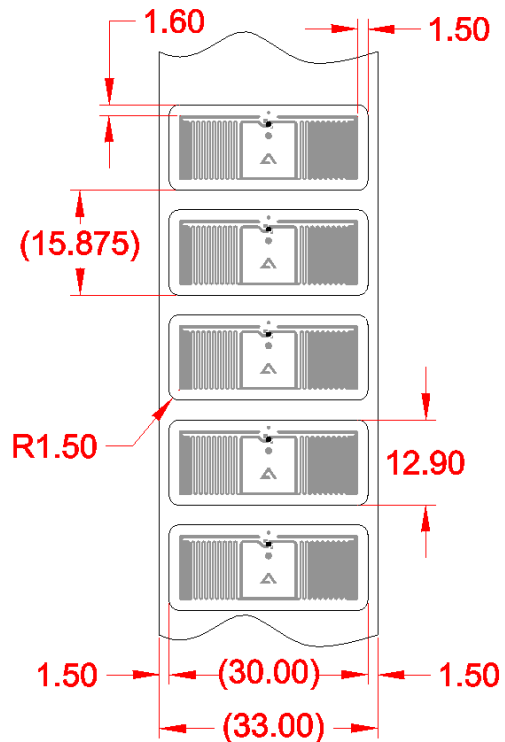

ALN-9715-WRW
(White Wet Inlay)



ALN-9715 Inlay Stackup

DRY INLAY THICKNESS, ±10%	
OVER ANTENNA	0.05 mm
OVER CHIP	0.25 mm

WHITE WET INLAY THICKNESS, ±10%	
OVER ANTENNA	0.16 mm
OVER CHIP	0.36 mm

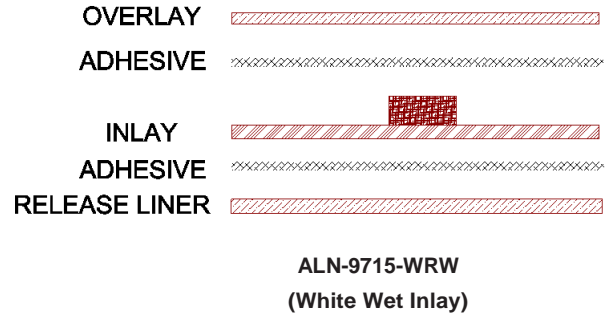
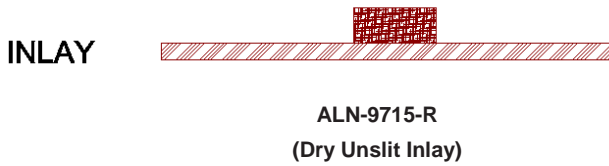

ALN-9715 Inlay Angular Sensitivity

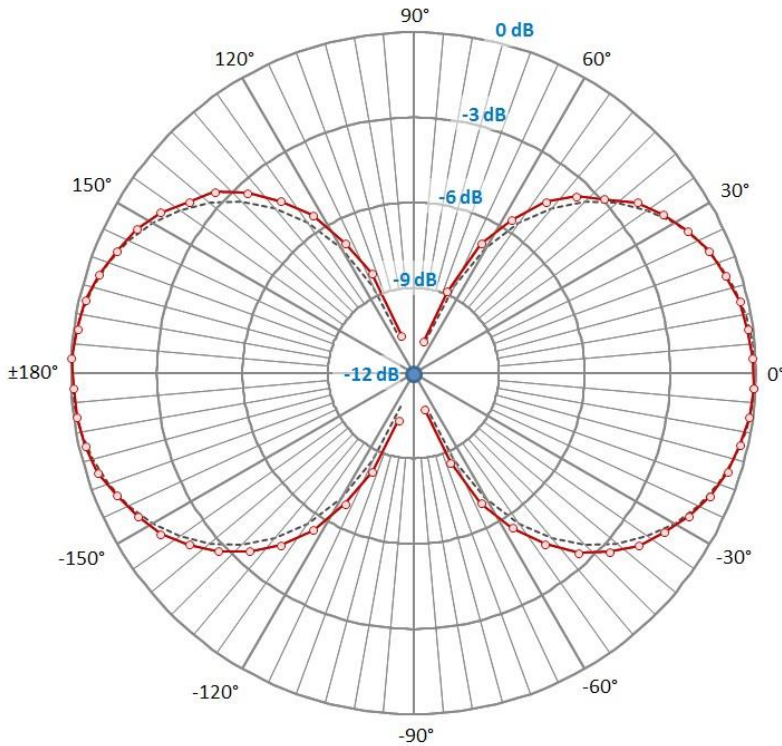

Angular Sensitivity
(Relative Read Range vs. Orientation)

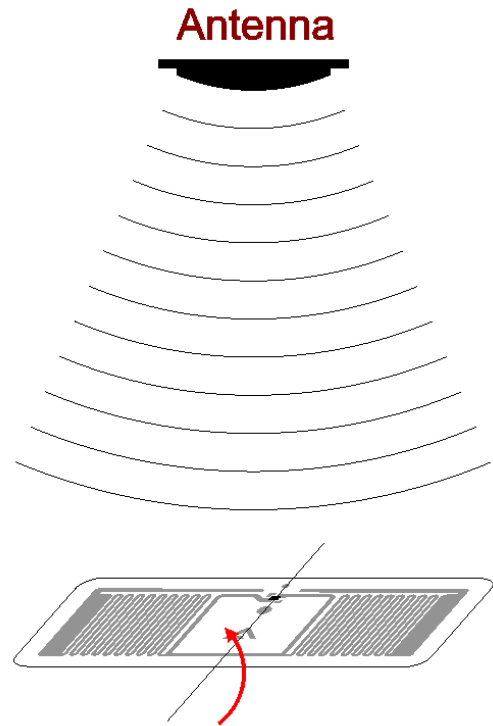

Angular Sensitivity
Inlay is rotated in the x, y, plane about the z axis

ALN-9715 Specifications

Dry Inlay

Antenna Width	1.06" [27mm]
Antenna Length	0.38" [9.7mm]
Web Width	1.575" [40.0mm]
Web Pitch	0.625" [15.875mm]
Core Width	1.575" [40.0mm]
Core ID	6" [152.4mm]*
Core Material	Fiberboard
Inlays per Roll	20,000 Nominal
Maximum Roll OD	< 12" [304.8mm]
Roll Labeling Data	Roll #, Quantity

Wet Inlay

Inlay Width	1.18" [30mm]
Inlay Length	0.51" [12.9mm]
Web Width	1.23" [33mm]
Web Pitch	0.625" [15.875mm]
Core Width	1.23" [33mm]
Core ID	6" [152.4mm]*
Core Material	Fiberboard
Inlays per Roll	20,000 Nominal
Maximum Roll OD	< 16" [406.4mm]
Roll Labeling Data	Roll #, Quantity
White	TT Printable White Film Only
Overlay Adhesive	General Purpose Permanent
Inlay Adhesive	General Purpose Permanent
Adhesive Application Temperature	> +25°F [-4°C]
Adhesive Service Temperature	-40°F to +200°F [-40°C to +93.3°C]
Release Liner	40# SCK

Environmental

Shelf Life	Dry Inlays: 5 years at +77°F [+25°C] @ 40% RH Wet Inlays: 2 years at +77°F [+25°C] @ 40% RH
Recommended Storage	+77°F [+25°C] @ 40% RH
Storage Limits	-13°F to 122°F [-25°C to +50°C] 20% to 90% RH Non-condensing
Operating Limits	-40°F to +158°F [-40°C to +70°C] 20% to 90% RH Non-condensing
Bend Diameter	> 1.97" [50mm]
Pressure	< 5N/mm ²
Drop Resistance	Per ASTM D5276
Write Cycles	100,000 @ 25°C
RoHs	2002/95/EC, 2005/618/EC, 2011/65/EU Compliant
REACH	1907/2006/EC Compliant (SVHC and ECHA)
ESD Limit– HBM / CDM	5.0kV / 1.5kV

RFID

Protocols Supported	ISO/IEC 18000-6C EPCglobal Class 1 Gen 2
Integrated Circuit	Alien Higgs-4
Operating Frequency	840–960 MHz
EPC Size	128 Bits
User Memory	128 Bits
TID	32 Bits
Unique TID	64 Bits
Access Password	32 Bits
Kill Password	32 Bits

* Shipped with 6" to 3" plastic core adapter

October 10, 2016

Copyright© 2016 Alien Technology LLC. All rights reserved.

Alien, Alien Technology, the Alien Technology logo, Spider, Higgs, Dynamic Authentication, QuickWrite, BlockWrite, Squiggle, and the Squiggle logo are trademarks or registered trademarks of Alien Technology Corporation in the U.S. and other countries.

HANDLING PRECAUTIONS Observe standard handling practices to minimize ESD.

DISCLAIMER Application recommendations are guidelines only - actual results may vary and should be confirmed. This is a general purpose product not designed or intended for any specific application.

This product is covered by one or more of the following U.S. patents: 7967204, 7931063, 7868766, 7737825, 7716208, 7716160, 7688206, 7659822, 7619531, 7615479, 7598867, 7580378, 7576656, 7562083, 7561221, 7559486, 7559131, 7554451, 7551141, 7542301, 7542008, 7531218, 7522055, 7500610, 7489248, 7453705, 7425467, 7417306, 7411503, 7385284, 7377445, 7364084, 7353598, 7342490, 7324061, 7321159, 7301458, 7295114, 7288432, 7265675, 7262886, 7260882, 7253735, 7244326, 7218527, 7214569, 7199527, 7193504, 7173528, 7172910, 7172789, 7141176, 7113250, 7101502, 7080444, 7070851, 7068224, 7046328, 6998644, 6988667, 6985361, 6980184, 6970219, 6952157, 6942155, 6933848, 6927085, 6816380, 6780696, 6731353, 6693384, 6683663, 6665044, 6657289, 6623579, 6606247, 6606079, 6590346, 6586338, 6566744, 6555408, 6527964, 6479395, 6468638, 6420266, 6316278, 6291896, 6281038. Other patents pending.

This product is licensed under patents of Round Rock Research, LLC, for use solely with UHF RFID Readers (such as Alien reader products) that are licensed under an agreement with Round Rock Research, LLC.